

Nirbo water features are made from high quality stainless steel and engineering plastics materials, therefore they are very durable and have excellent fun factor. There are over one hundred different water features to choose from, this product is just a great example. We use brass or stainless steel nozzles which are ideal materials for the application.

Curved Water Ups | 03637

GPM	Max PSI	LPM	Max Bar
12	10	48	0.7
Width	Length	Height	
52" (132 cm)	98" (249 cm)	12" (31 cm)	

Nirbo Aquatic Inc.

2400 Lucknow Drive, unit 39, Mississauga, ON L5S 1T9, Canada
 Toll Free: 1.888.68.NIRBO (64726) | Tel: 1.905.766.4474 | Fax: 1.905.766.4467
 Website: www.nirbo.com | Email: info@nirbo.com

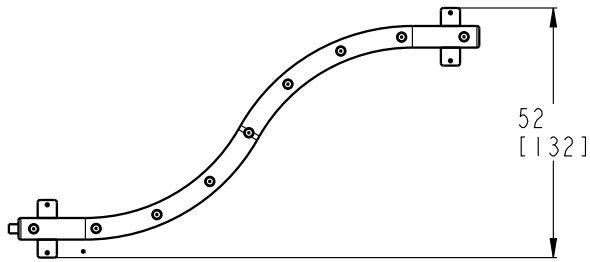

FOR FOOTING DETAILS SEE
DRAWING NO: 03008-22

GROUNDING
BOLT

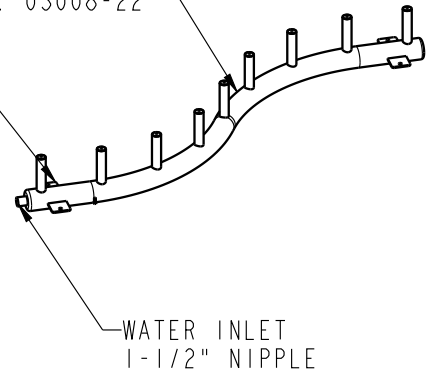

WATER INLET
1-1/2" NIPPLE

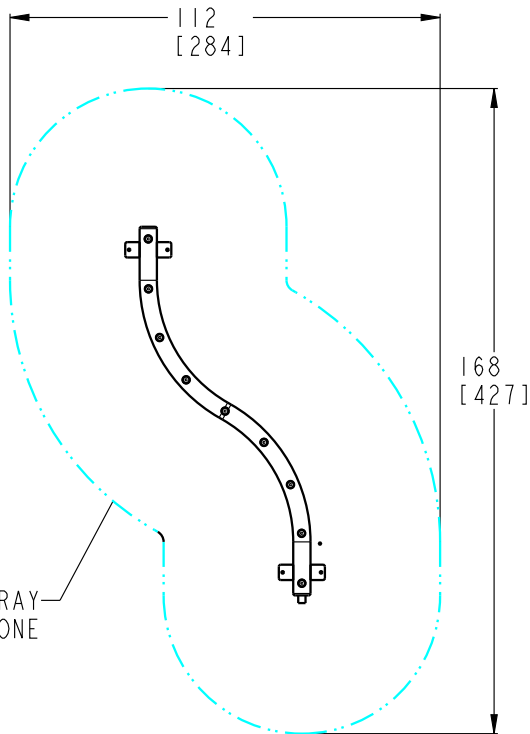
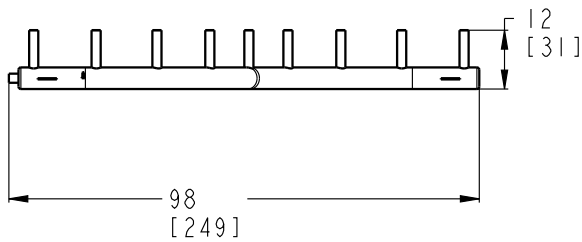

SPRAY
ZONE

SCALE 1:50

FLOW RATE AT 5 PSI	LOW	NORMAL	HIGH
GPM-[LPM]	12[48]	20[72]	27[108]

- 1- STRUCTURE: TYPE 304 STAINLESS STEEL
NOZZLE: BRASS WITH TAMPER RESISTANT FEATURES
- 2- FINISH: NONE
- 3- PRODUCT INCLUDES:
ANCHOR BOLTS WITH HARDWARE AND FOOTING TEMPLATE
SPRAY NOZZLES
WINTER NOZZLE CAPS
SERVICE TOOLS
TAMPER RESISTANT HARDWARE
- 4- GROUND COMPONENT WITH #6 BARE COPPER WIRE
- 5- PRODUCT COMPLIANCE:
MEETS ADA ACCESSIBILITY GUIDELINES
MEETS CURRENT ASTM F1487 SAFETY STANDARDS

**NIRBO
AQUATIC INC.**

ALL INFORMATION CONTAINED
IN THIS DOCUMENT IS PROPERTY
OF NIRBO AQUATIC INC. AND
MAY NOT BE REPRODUCED OR
COMMUNICATED WITHOUT
PERMISSION IN WRITING FROM
NIRBO AQUATIC INC.

DATE
(yyyy.mm.dd)
2013.11.29

CURVED WATER UPS

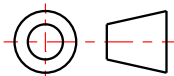

UNIT
INCH
[CM]

SHEET
1/2

DRAWING NO
03637-01-D15

REV
01

Nirbo Aquatic Inc.
Tel: 1-905-766-4474, Fax: 1-905-766-4467, Web: www.nirbo.com

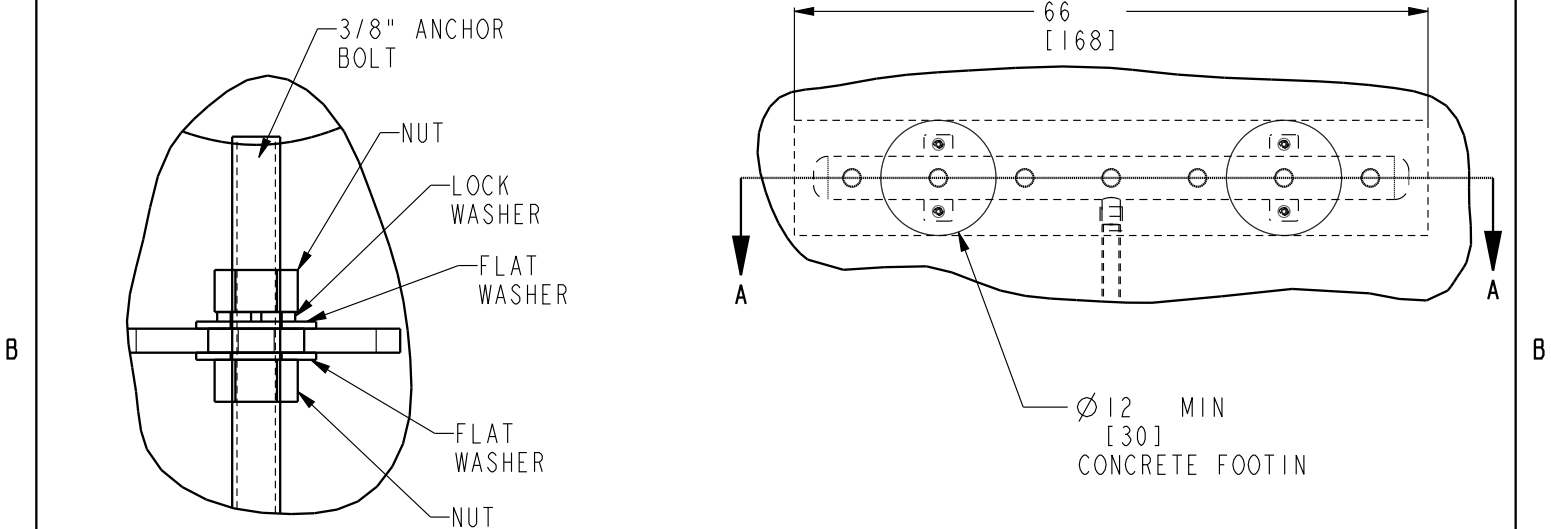

DETAIL A
SCALE 1:2

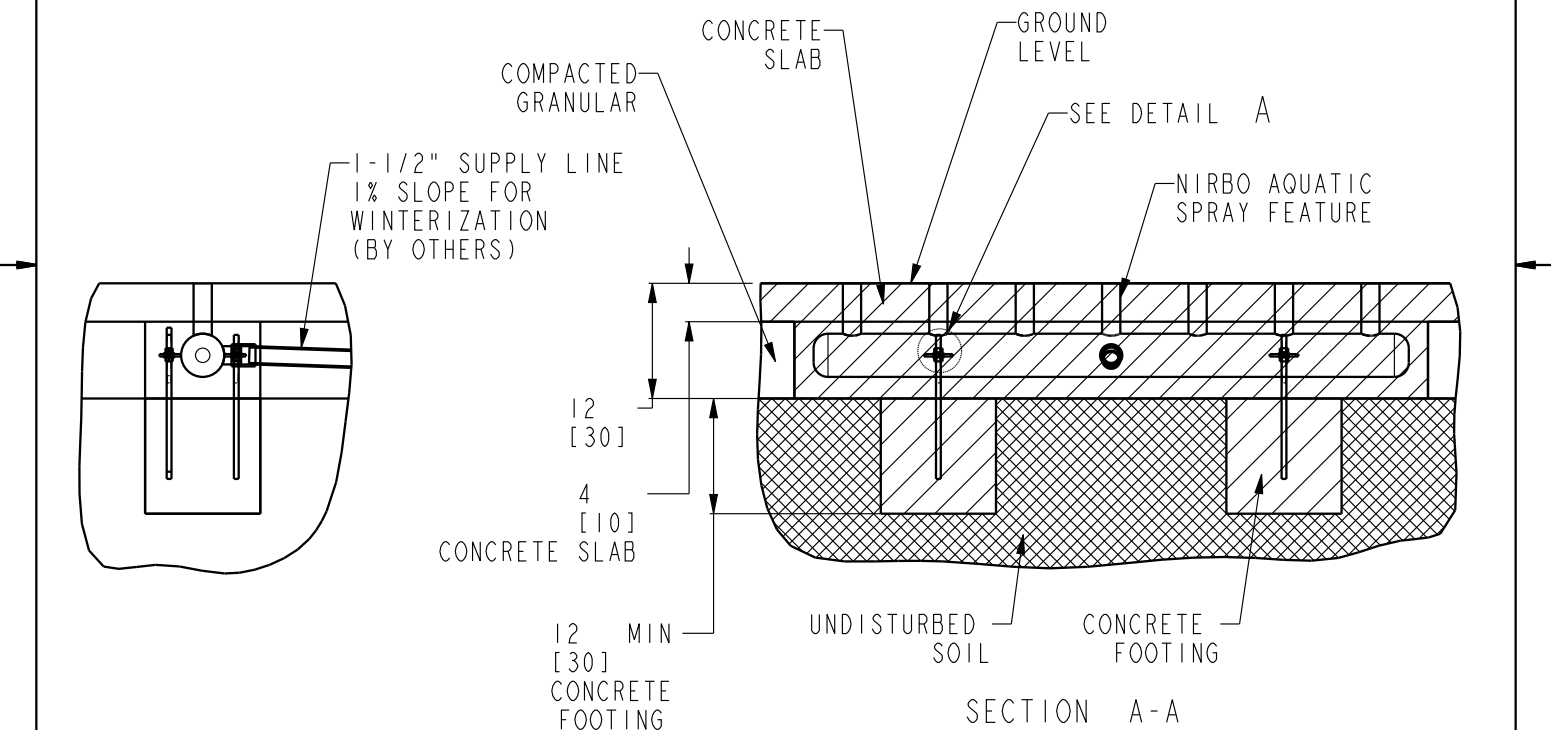

NOTES:

- 1- FOLLOW LOCAL CODES, WHEREVER APPLICABLE.
- 2- GRANULAR BASE THICKNESS SHALL MEET LOCAL BUILDING CODE REQUIREMENTS.
- 3- WATER SUPPLY LINE SHALL BE INSTALLED PER LOCAL BUILDING CODES.
- 4- HARDWARE SUPPLIED BY MANUFACTURER SHALL BE USED.

NIRBO AQUATIC INC.	ALL INFORMATION CONTAINED IN THIS DOCUMENT IS PROPERTY OF NIRBO AQUATIC INC. AND MAY NOT BE REPRODUCED OR COMMUNICATED WITHOUT PERMISSION IN WRITING FROM NIRBO AQUATIC INC.	DATE (yyyy.mm.dd) 2013.10.21	INSTALLATION		
		UNIT INCH [CM]	SHEET 1 / 1	DRAWING NO 03008-22	REV 01